



Turkish Coffee Maker
User Manual

BKK 2113



Please read this manual first!

Dear Customer,

We hope that your product which has been manufactured in modern facilities and passed through a strict quality control procedure will give you the best results.

Therefore, we advise you to read through this manual carefully before using your product and keep it for future reference.

This user manual will...

... help you use your machine in a fast and safe way.

- Please read the User Manual before installing and starting your machine.
- Particularly follow the instructions related to safety.
- Keep this User Manual within easy reach. You may need it in the future.
- Please read all additional documents supplied with this machine.

Please note that this User Manual may be applicable for several other models. Differences between models will be identified in the manual.



This product has been produced in environmentally friendly, modern facilities

CONTENTS

1 Safety Warnings	2-3
Compliance with WEEE Directive and Disposing of the Waste Product	4
Compliance with RoHS Directive	4
Package information	4
2 Technical Aspects of Your Machine	5
3 Recommendations on How To Cook Turkish Coffee	6
4 Using Your Machine	7-10
Filling up the water reservoir	7
Adjusting the amount of water according to your cup	8
Boiling	9
5 Maintenance and Cleaning	11-12
Important notes	11
6 Superior Technological Aspects	13

1 Safety Warnings

- Always plug your machine into a GROUNDED OUTLET.
- Do not place and use your machine near heat sources (i.e. oven, barbecue, radiators, heaters, etc.).
- Keep your machine away from steam sources and try not to use it in steamy environments.
- Do not put anything else (like milk) in the water reservoir other than water.
- Do not put anything into the Mug with non-stick other than coffee and sugar; water fills into the boiling reservoirs automatically.
- The Turkish Coffee Maker is designed to work in 4-37°C 80% relative humidity.
- Do not use the Mug with non-stick on any other heater (stove etc.) than the Turkish Coffee Maker.
- Do not drink the Turkish Coffee directly from the Mug with non-stick.
- Do not ever put hot water into the water reservoir.
- Do not touch the Mug with non-stick and the surface of the heater. Always use the handle to hold the boiling compartment.
- Keep the Supply cord away from the stove and hot heating surfaces.
- If the Supply cord gets damaged, apply to an authorized service center for replacement.
- When the water alert signal lights up, please fill the water reservoir with water. (Max: 1 lt) Otherwise your machine will not work.
- After using the machine, please turn it off from the on/off switch. Show care to not to leave it on.
- Do not use your machine outdoors.
- Your product is designed to be used for home Appliance, not for commercial use.
- Please make sure that the machine is unplugged when it is not used and especially during cleaning.

1 Safety Warnings

- Due to the production technology applied, your product might emit steam and odor at the first use. This is normal for your machine. It will recover after the first few uses.
- Do not wash the Mug with non-stick and the water reservoir in the automatic dishwashing machine.
- The instructions shall state the substance of the following:
This appliance is not intended for use by persons (including children) with reduced physical, sensory or mental capabilities, or lack of experience and knowledge, unless they have been given supervision or instruction concerning use of the appliance by a person responsible for their safety. Children should be supervised to ensure that they do not play with the appliance.
- Your machine will switch to standby mode automatically after a beep sound if no process is carried out for 3 minutes. The device will be supplied power together with a warning sound when you place the cooking reservoir into its seating or take it out from its seating!

Compliance with WEEE Directive and Disposing of the Waste Product:



This product complies with EU WEEE Directive (2012/19/EU). This product bears a classification symbol for waste electrical and electronic equipment (WEEE).

This product has been manufactured with high quality parts and materials which can be reused and are suitable for recycling. Do not dispose of the waste product with normal domestic and other wastes at the end of its service life. Take it to the collection center for the recycling of electrical and electronic equipment. Please consult your local authorities to learn about these collection centers.

Compliance with RoHS Directive:

The product you have purchased complies with EU RoHS Directive (2011/65/EU). It does not contain harmful and prohibited materials specified in the Directive.

Package information

Packaging materials of the product are manufactured from recyclable materials in accordance with our National Environment Regulations. Do not dispose of the packaging materials together with the domestic or other wastes. Take them to the packaging material collection points designated by the local authorities.

2 The Technical Aspects Of Your Machine

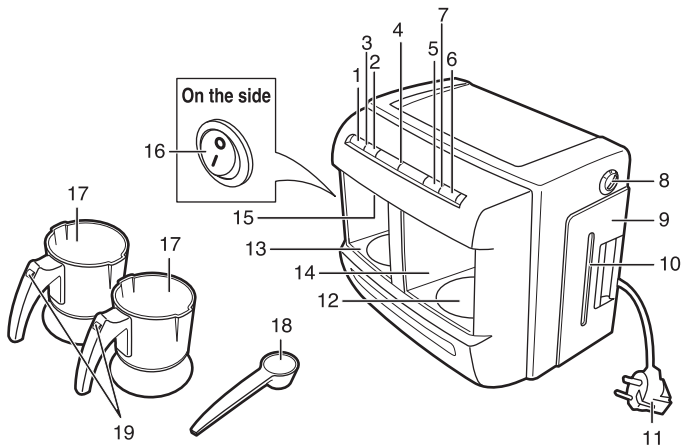

1. Side A - single cup coffee button
2. Side A - double cup coffee button
3. Side A - status light
4. Machine status light (water indicator light)
5. Side B - single cup coffee button
6. Side B - double cup coffee button
7. Side B - status light
8. Cup water adjustment button
9. Water reservoir
10. Water reservoir level window
11. Supply cord
12. Heating surface
13. Cooking station A
14. Cooking station B
15. Boiling sensor (at the top)
16. On-Off switch (on the side)
17. Mug with non-stick
18. Measuring spoon
19. Sugar reminder button

Current	: Single heater Max 3A Double heater Max 6A
Voltage	: 220-240 V ~ 50/60 Hz
Operating power	: 1200 W (for 220 V~) 1470 W (for 240 V~)
(Cooking)	
Water reservoir volume	: 1 lt
Length of the supply cord	: 130 cm
Net weight	: 4.1 kg

The values indicated on the indicators of the product or on other printed documents that are provided with the machine, are obtained at laboratory surroundings according to related standards. These values may change according to usage of the machine and the conditions of the environment in which the machine is used.

3 Recommendations On How To Cook Turkish Coffee

This product is a practical machine, which is designed to cook Turkish Coffee. Using the appropriate measuring indicated in the Table below, you can make foamy Turkish

Coffee convenient for every taste. The measuring indicated below are just provided as guidance. You can adjust these according to your own personal taste.

Recommened ingredient measurings for preoaration of Turkish Coffee				
	Plain	W/Little sugar	Medium	W/Sugar
Coffee	1 measuring cup	1 measuring cup	1 measuring cup	1 measuring cup
Sugar	–	1/2 cubic sugar/ 1/2 teaspoonful of sugar	1 cubic sugar/ 1 teaspoonful of sugar	2 cubic sugar/ 2 teaspoonful of sugar

- The measuring is provided for medium sized cups and for one person.
- As a measuring Spoon for coffee, you can use the Spoon that is

placed inside the Turkish Coffee Maker.

- Use fresh coffee in order to make delicious and foamy Turkish Coffee.

4 Using Your Machine

Filling up the water reservoir

1. You can fill the water reservoir by opening the lid at level 1 (Figure 1).
2. You can check the water level from the water reservoir window (Figure 2).
3. When the water in the tank is finished, water indicator light on the front panel will light up pink. In this case, you cannot make new coffee without adding water to the reservoir first (Figure 3).

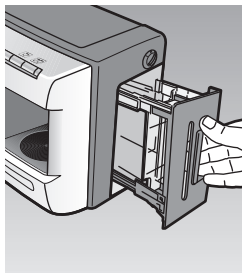

Figure 1

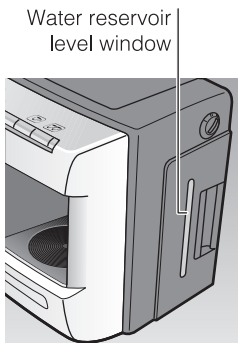

Figure 2

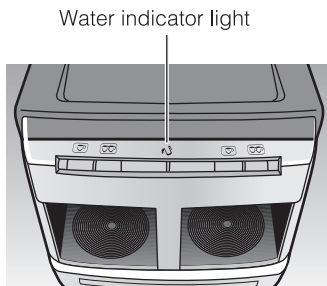

Figure 3

Adjusting the amount of water according to your cup

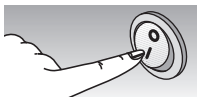

Figure 1



Figure 2

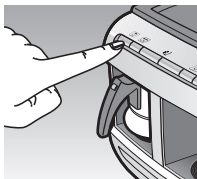

Figure 3

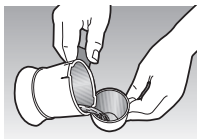

Figure 4

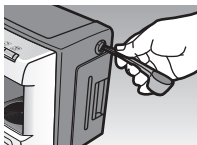

Figure 5

1. Plug the cord of the machine into the outlet.
2. Press the On-Off button (Figure 1).
3. Put the coffee pot onto the boiling dish without adding anything (Figure 2).
4. Press single coffee cup button (Figure 3).
5. When the operating sound of the pump ends after 4-5 seconds, terminate the operation by keep pressing the single coffee cup button (for 1 second). At the end of this process, the machine will give error signal and the status indicator light will blink and turn blue. In this way, you can see how much water is taken into the Mug with non-stick. Pour the water in the Mug with non-stick into the cup you regularly use (Figure 4). If the water amount is low, adjust the cup water button to one level up, if the water amount is high, adjust it to one level down. If the amount is appropriate, do not make any adjustments (Figure 5).
6. Make the water adjustment when you start using the machine for the first time and repeat it every time you change the size of the cup.

Boiling

1. Put the plug into the outlet.

2. Press the On-Off switch. When the status is adjusted as shown in Figure 1, the status light on the front panel will turn blue.

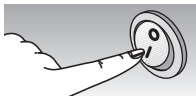

Figure 1

3. If the reservoir warning light is blinking pink, add water (ref. Pg 5 filling up the water reservoir)

4. Put coffee and sugar into the Mug with non-stick for one or two cups according to the amounts recommended in Table 3 (Figure 2).



Figure 2

Note: Be careful to keep the inside of the Mug with non-stick clean and dry to maintain the delicious taste.

5. Place the Mug with non-stick into the machine (Figure 3). If you do not place the Mug with non-stick right, the machine will not operate.



Status indicator lights up blue

Figure 3

6. Press, one cup or double cup button on the front panel according to the amount of coffee you wish to make.

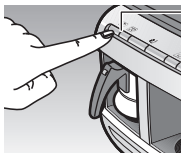

Status indicator on side A lights up blue

Figure 4

7. The machine will give a start signal and the side status indicator will light up blue.

8. The Cooking time for 1 cup is 1.5-2 minutes. The boiling time for 2 cups is 2.5-3.5 minutes. When you use your machine consecutively, the boiling time will shorten since the heater will be hot.

9. Once the boiling is done, the machine will give an audible warning signal and the side status light turn blue and start blinking. Take it out before waiting too long for a tasteful coffee! (Figure 5).

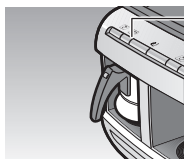

Status indicator blinks blue

Figure 5

10. After the boiling is done pour the coffee into the cup and it is ready for service!

Note: In order not to leave the foam and the coffee grounds in the Mug with non-stick, pour it into the cup fast.

11. By operating both Mug with non-stick of the machine, you can prepare Turkish Coffee for maximum of 4 people.

12. You can make different types of coffee (plain in one and with sugar in the order one) at the Mug with non-stick at the same time. With the help of the coffee/sugar reminders, you will not mix the Mug with non-stick.

If, for any reason, you need to stop the boiling process, just press the single or double cup button pertaining to that side (3 seconds).

Note: Do not try to re-cook before emptying the compartment! It might overflow because of the new intake of water and your coffee might be diluted.

5 Maintenance and Cleaning

1. Before starting to clean, unplug the machine.

2. Clean the Mug with non-stick immediately after every use so that the next time you prepare coffee, the taste will not be spoiled.

3. Do not wash any part of the machine other than Mug with non-stick and the water reservoir. You can wipe it with moist cloth.

4. Wipe the boiling sensor with moist cloth after every 15-20 services (Figure 1).

5. Do not wash the water reservoir and the water tank in the automatic dishwashing washing.

6. Take the water reservoir out completely only for cleaning. When you completely dismantle the water reservoir for cleaning purposes, a little amount of water can spill on to the base of the machine. That is normal. When filling with water, it is enough to open the lid of the water reservoir up to level 1 (Figure 2).

7. In order to clean the white stains (residue) that might form inside the Mug with non-stick in time as a result of usage without damaging the non-stick coated surface of the compartment, pour a mixture of half a cup of water and half a cup of vinegar into the Mug with non-stick and press single cup coffee button.

After it is done, you can rinse and reuse the Mug with non-stick.

8. After dismantling and re-mounting the water reservoir, if your cup does not fill up completely in single or double cup modes, put the Mug with non-stick into its place. While pressing single cup coffee button, press on double cup coffee button at the same time, too. The Mug with non-stick will fill up with water for 10 seconds. By doing this, you enable the pump in your machine to work properly again (Figure 3). After dumping this water, you can start making coffee.

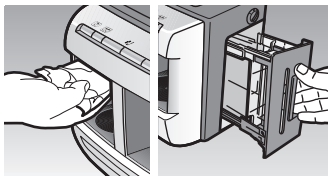

Figure 1

Figure 2



Figure 3

Important notes

1. Do not use scratching sponge or screen cloth to clean the heating surface and the bottom surfaces of the Mug with non-stick. Be careful not to get these surfaces scratched (Figure 1-2).

2. Be careful not to get heating surfaces stained (Figure 2). When coffee drips on to the heating surfaces, wipe them before they get dry.

3. The lime in the tap water might damage the product, it is preferable to use bottled spring water. Do not use processed water.

4. If you try to operate the Turkish coffee maker under 4°C, it will not work since the water in the reservoir will freeze.

When changing the place of your product, be sure that there is no water left inside. Take the water reservoir out and empty it. Place the water reservoir back in the machine and wait for a few seconds while holding it at a 45° angle, as shown in the picture. Take the water reservoir out and dump the remaining water. Having done this,

you can move your product safely. Do not move the product while the Mug with non-stick are mounted on the machine. If the Mug with non-stick fall, they might get damaged.



Figure 1

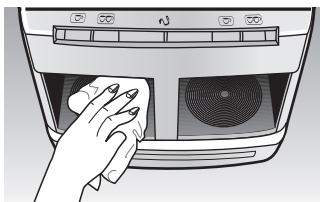
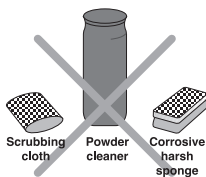

Figure 2



Do not use abovelisted materials to clean the product.

6 Superior Technological Aspects

SpinJet



water jet mixing
system

Automatic mixing system that enables the coffee to have foam and the right thickness.

CookSense



brewing detecting
system

The technology that enables the coffee to be cooked with ideal thickness.

AntiSpill



boil over preventing
system

Additional safety system that eliminates the need to stand by while the coffee is being made.

Revizyon No: AD

Stok No: 3001831500